

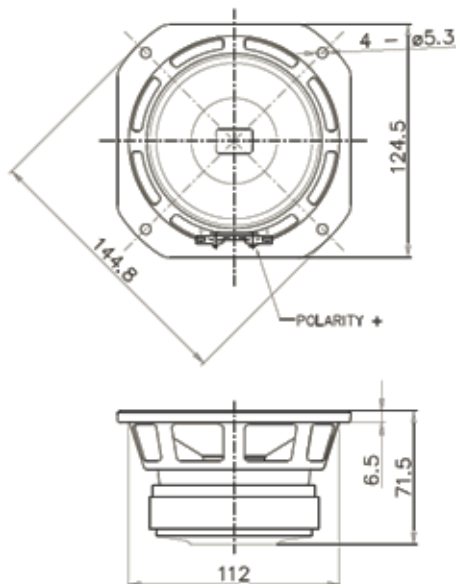

5FE100 Fe Series



NOMINAL SPECIFICATIONS

Nominal Diameter	130 mm (5 in)
Overall Diameter	144.8/124.5 mm (5.7/4.9 in)
Bolt Circle Diameter	133 mm (5.24 in)
Baffle Cutout Diameter	112 mm (4.4 in)
Depth	65 mm (2.56 in)
Flange and Gasket Thickness	6.5 mm (0.25 in)
Net Weight	1.12 Kg (2.47 lb)
Shipping Box	393x362x118 mm
(Single Carton Box - 4 units)	(15.47x14.25x4.64 in)
Shipping Weight (4 units)	4.4 Kg (9.7 lb)

ELECTRICAL SPECIFICATION

Minimum Impedance	6.3 Ohm
Nominal Impedance	8 Ohm
Nominal Power Handling *	80 W
Maximum Power Handling **	160 W
Sensitivity (1W/1m)	88 dB
Frequency Range	65-6300 Hz
Voice Coil Diameter	32 mm (1.26 in)
Winding Material	Cu
Former Material	Kapton
Winding Depth	12.5 mm (0.49 in)
Magnetic Gap Depth	6 mm (0.24 in)
Flux Density	1 T

THIELE & SMALL PARAMETERS

Fs	65 Hz
Re	5.4 Ohm
Bl	6.9 N/A
Mms	10.5 g
Cms	0.57 mm/N
Rms	0.76 Kg/s
Qes	0.47
Qms	5.63
Qts	0.44
Vas	4.54 dm ³ (0.16 ft ³)
Sd	74.9 cm ² (11.6 in ²)
Xmax ***	5.25 mm
Xdamage ****	9.5 mm
Le	0.53 mH
Mmd	10.1 g
Eta Zero	0.25 %

ORDERING CODES

Faston Terminals - 8 Ohm Version	01303917
----------------------------------	----------

NOTES

Packaged and sold in multiples of 4 units

(*) 2 Hours Test According to AES 2-1984 Rev. 2003

(**) Maximum power is defined as 3dB greater than nominal power.

(***) $X_{max} = [(winding\ depth - magnetic\ gap\ depth) / 2] + (magnetic\ gap\ depth / 3)$

(****) Maximum excursion before permanent damage

CURVES

